

Kasten

zusätzlich:

1 Streifen schwarz: ca 31 cm lang + 10cm breit.

Falzen an den langen Seiten bei 1cm und 9 cm

1 Streifen grün: 10,5 cm lang + 9,4 cm breit.

Falzen an den langen Seiten bei 0,7 cm und 8,7 cm

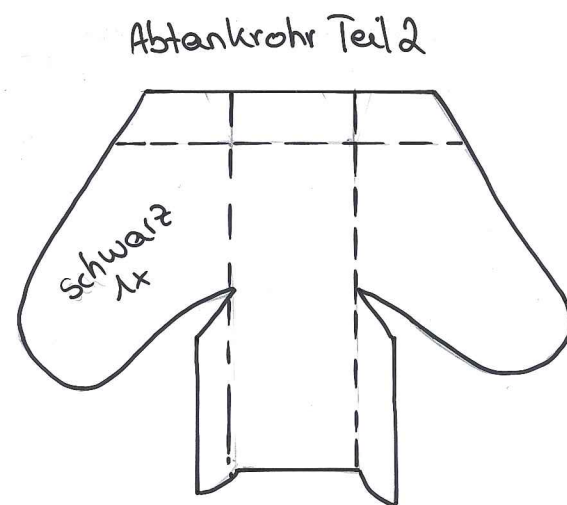

Abtankrohr Teil 2

Abtankrohr Teil 1

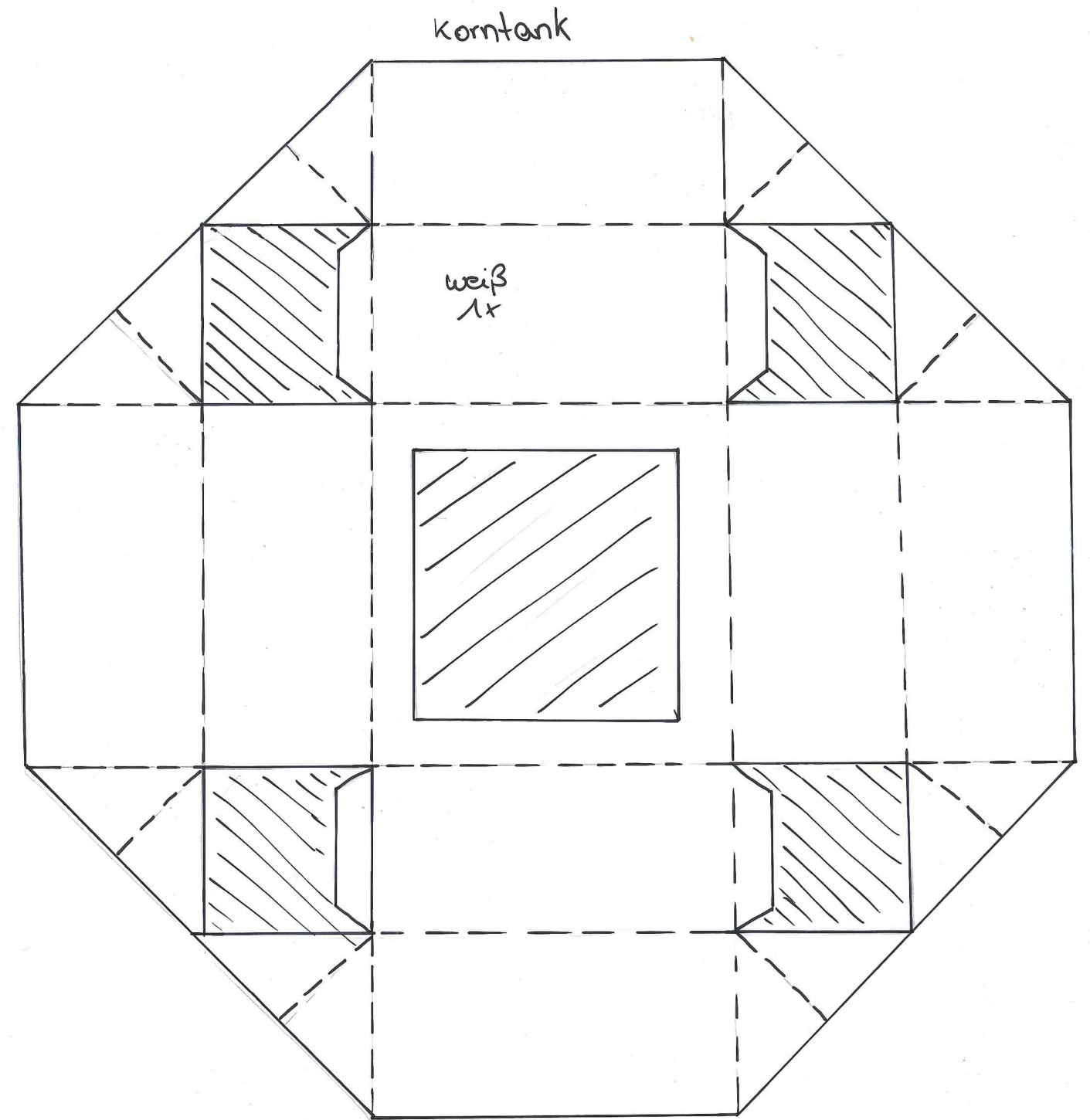
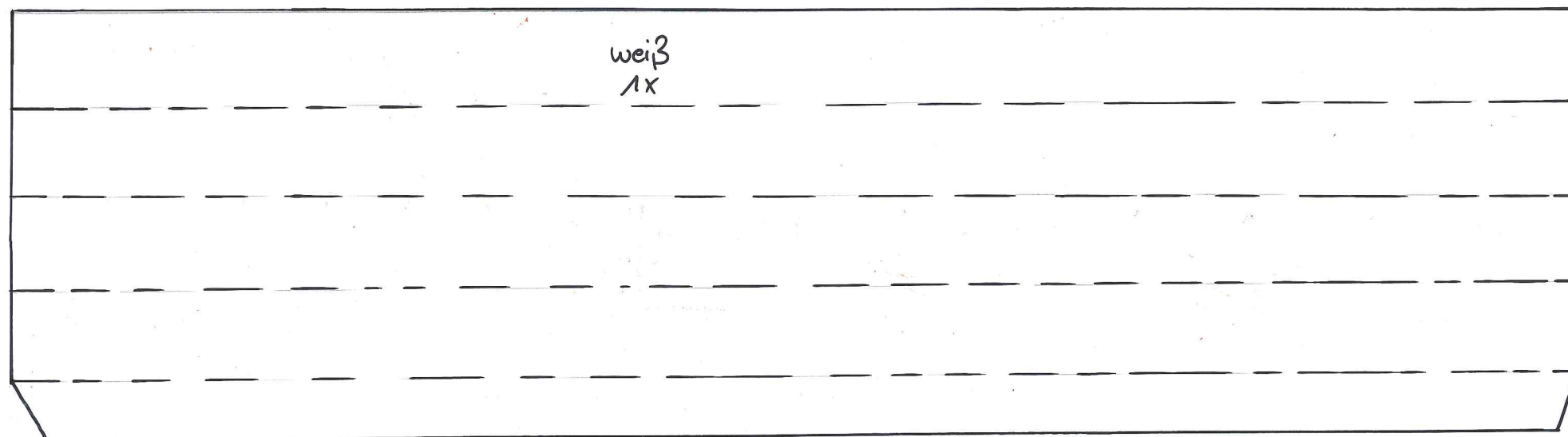

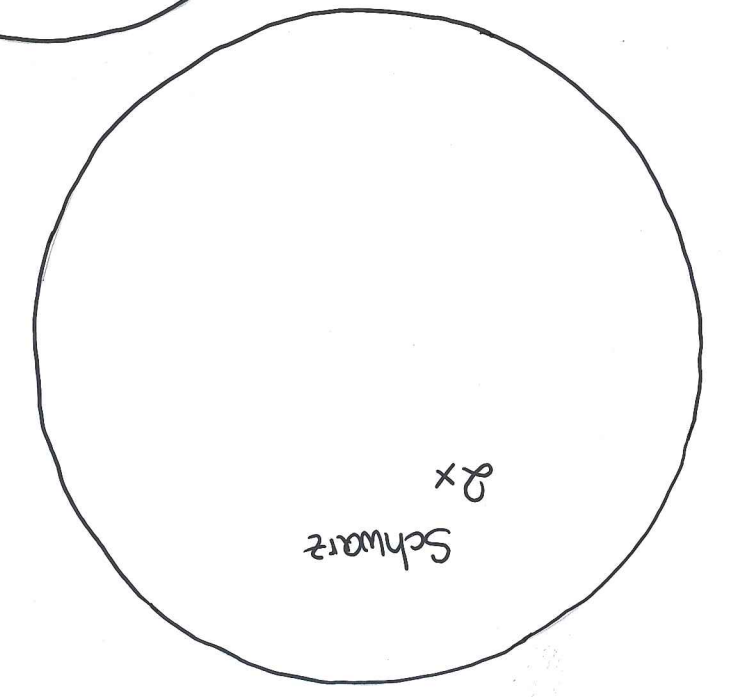
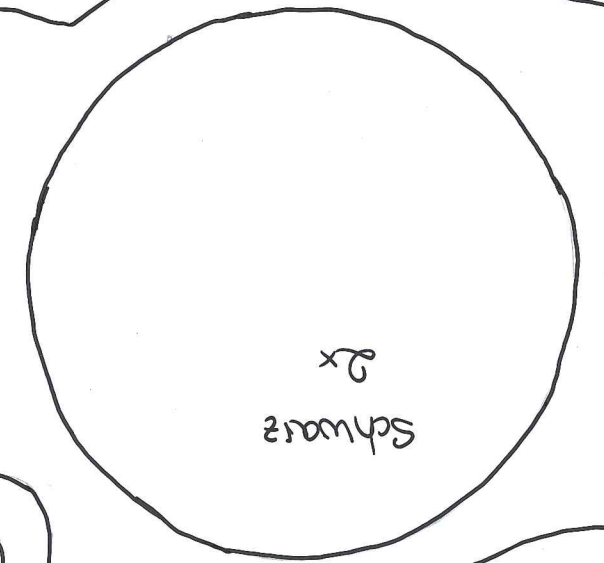
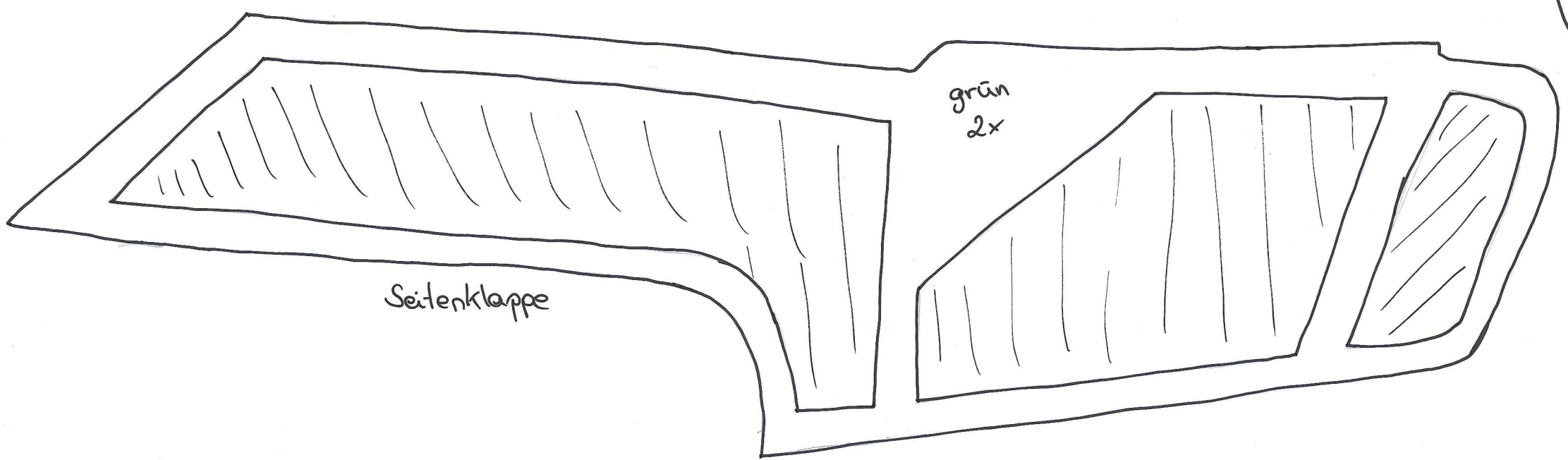
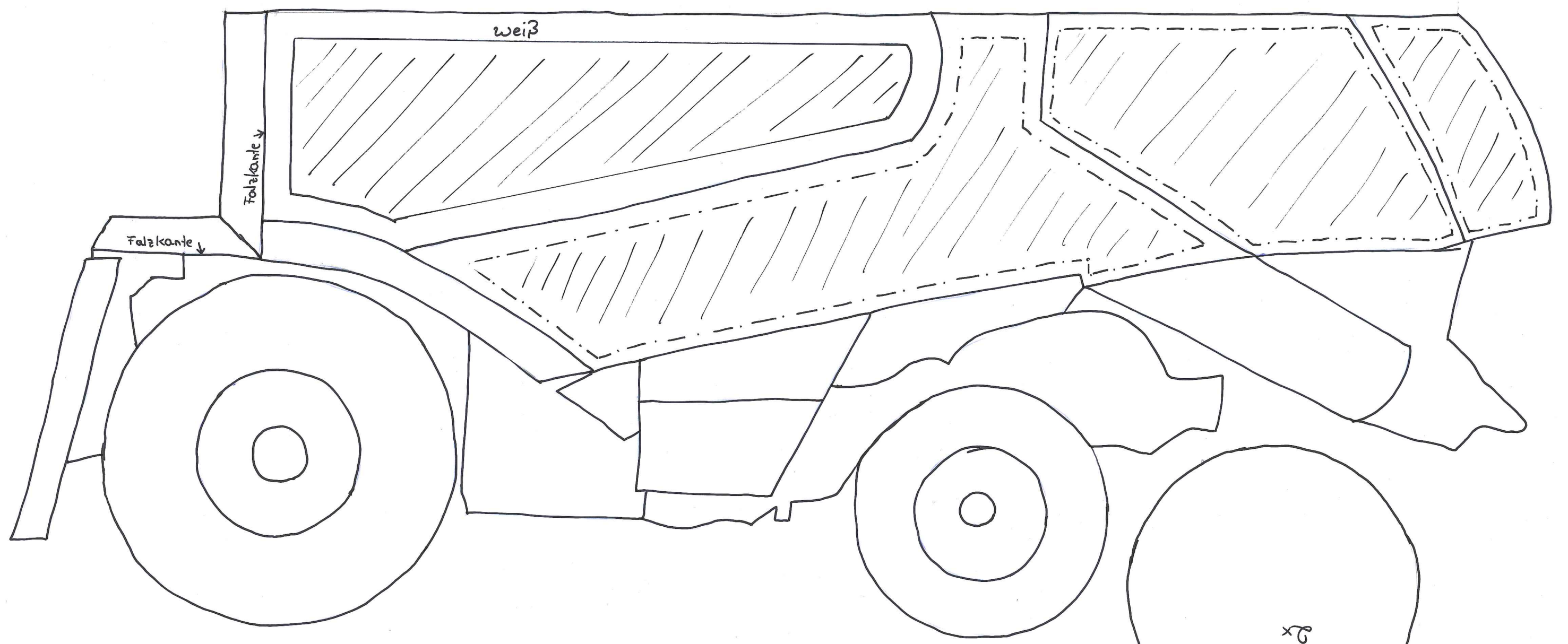

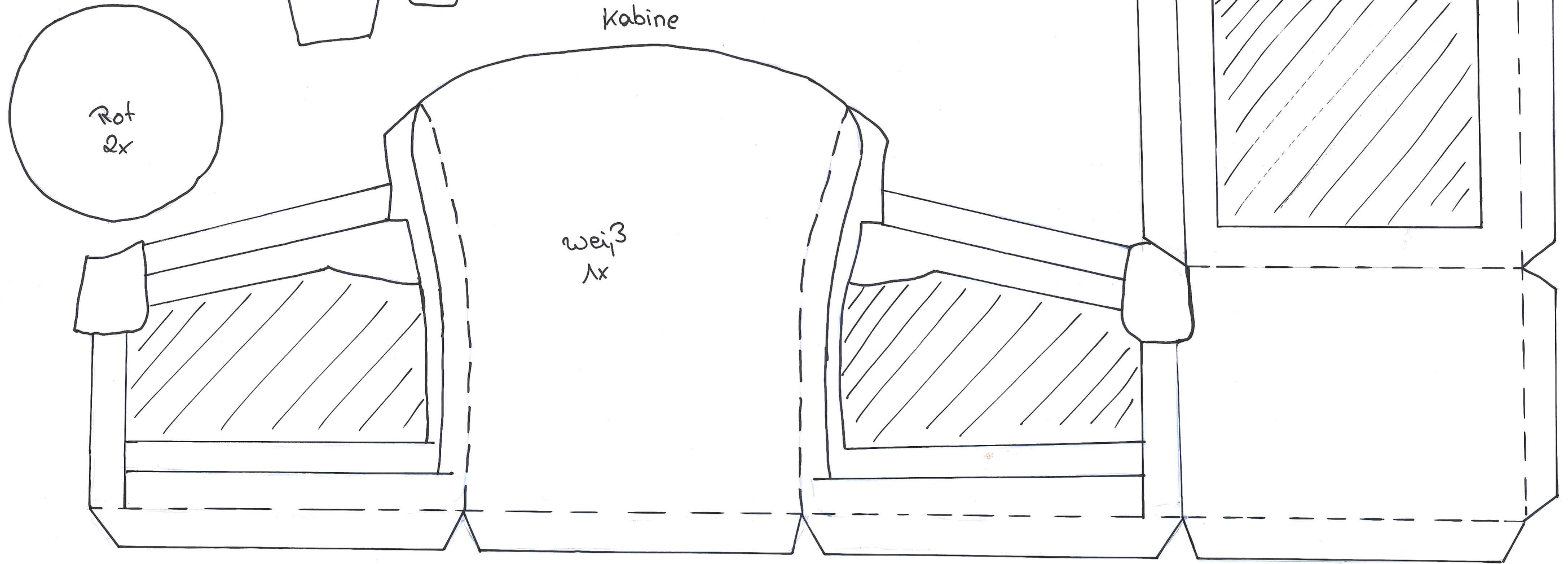
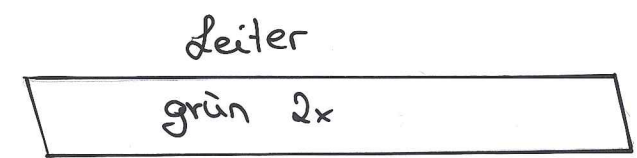
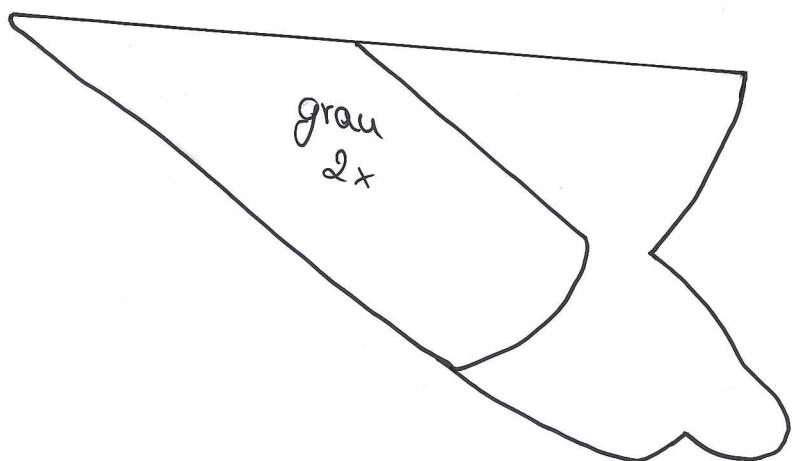
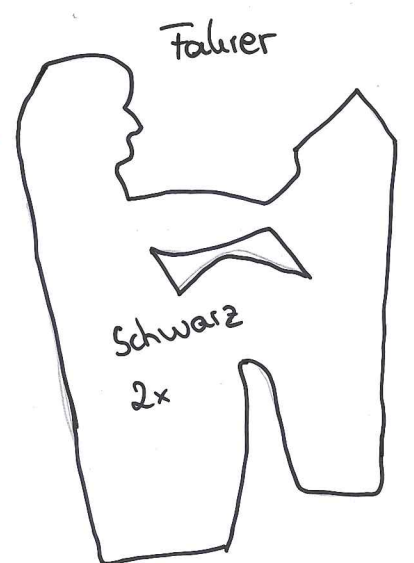
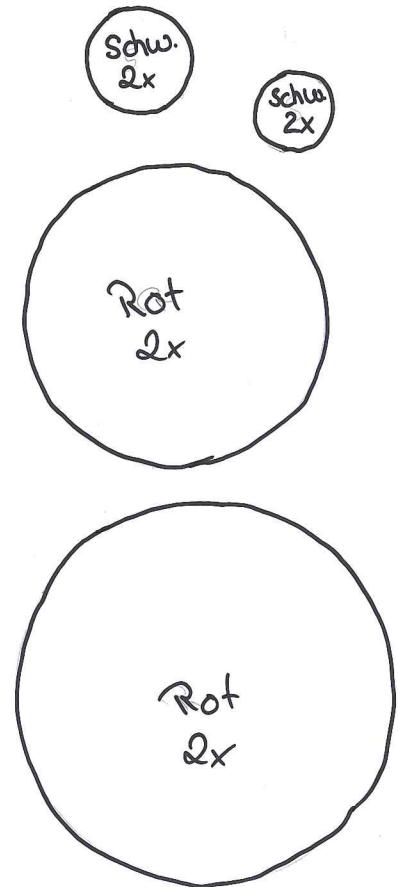
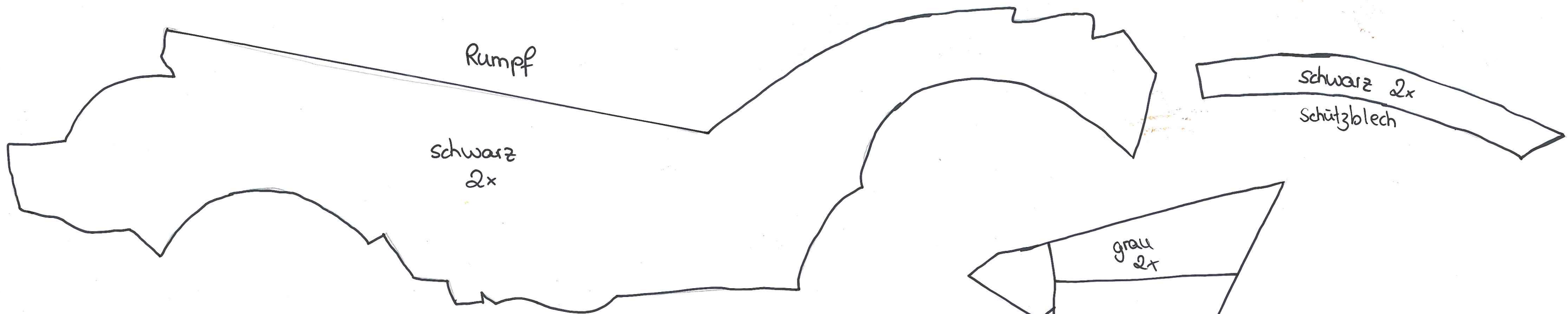

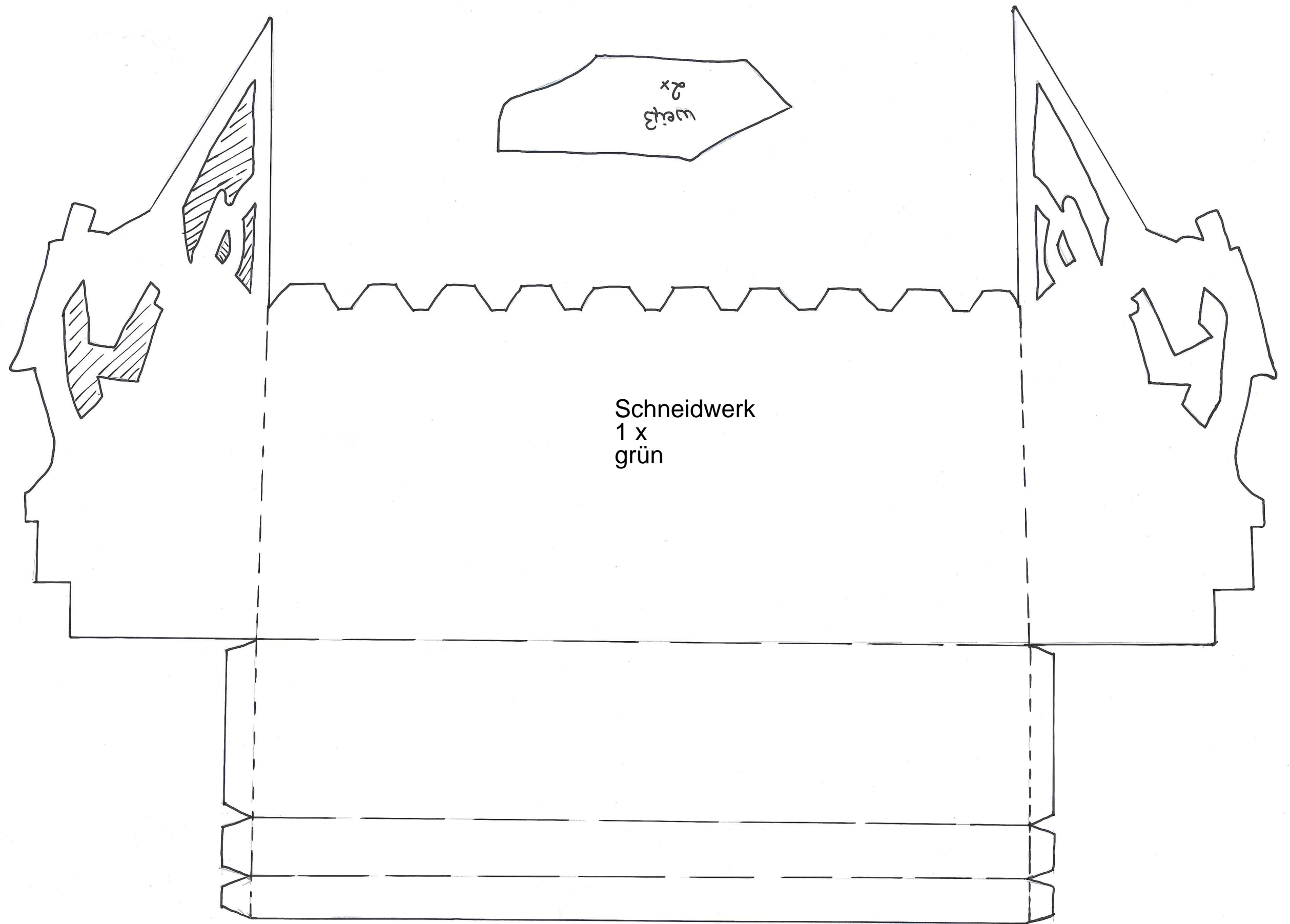

zusätzlich:
1 Streifen rot: 21,5 cm lang +16 cm breit.
In der Länge falzen bei 1 cm und 19,5 cm.
In der Breite falzen bei 2,5 cm, 50 cm,
7,5 cm, 10 cm, 12,5 cm und 15 cm